

# BLACKMER TRUCK PUMPS

## Installation Operation And Maintenance Instructions Supplement: Installing Base Mounted Pumps On Trucks

960469  
FORM 578

Section	Forms
Effective	Oct 2006
Replaces	New

This document addresses issues confronted when mounting a pump on a truck for use with a PTO or hydraulic drive system. This is a supplement manual and should **always** be used in conjunction with the standard pump manual.

Blackmer pump manuals and parts lists may be obtained from Blackmer's website ([www.blackmer.com](http://www.blackmer.com)) or by contacting Blackmer Customer Service.

### TABLE OF CONTENTS

	<i>Page</i>
Pump Identification .....	2
Truck Mounting .....	2
Pump Rotation .....	2
To Change Pump Rotation .....	2
Pump Speed .....	2
PTO Drives .....	3
Hydraulic Drives.....	3

### SAFETY DATA



#### This is a SAFETY ALERT SYMBOL.

When you see this symbol on the product, or in the manual, look for one of the following signal words and be alert to the potential for personal injury, death or major property damage



Warns of hazards that WILL cause serious personal injury, death or major property damage.



Warns of hazards that CAN cause serious personal injury, death or major property damage.



Warns of hazards that CAN cause personal injury or property damage.

#### NOTICE:

Indicates special instructions which are very important and must be followed.

#### NOTICE:

Blackmer Truck Pumps **MUST** only be installed in systems, which have been designed by qualified engineering personnel. The system **MUST** conform to all applicable local and national regulations and safety standards.

This manual is intended to assist in the installation and operation of the Blackmer truck pumps, and **MUST** be kept with the pump.

Pump service shall be performed by qualified technicians **ONLY**. Service shall conform to all applicable local and national regulations and safety standards.

Thoroughly review this manual, all instructions and hazard warnings, **BEFORE** performing any work on the pump.

Maintain **ALL** system and pump operation and hazard warning decals.

# SAFETY DATA



Failure to set the vehicle emergency brake and chock wheels before performing service can cause severe personal injury or property damage.

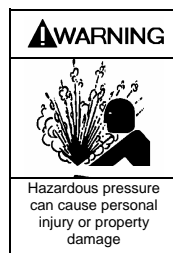

Disconnecting fluid or pressure containment components during pump operation can cause serious personal injury, death or major property damage

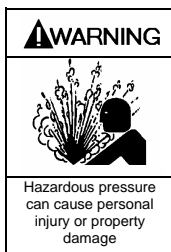

Failure to relieve system pressure prior to performing pump service or maintenance can cause personal injury or property damage.

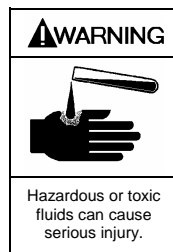

If pumping hazardous or toxic fluids, system must be flushed prior to performing service

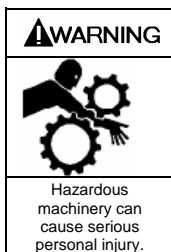

Failure to disconnect and lockout electrical power or engine drive before attempting maintenance can cause severe personal injury or death



Operation without guards in place can cause serious personal injury, major property damage, or death.

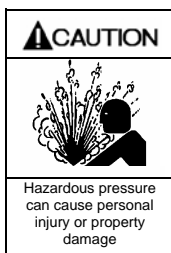

Pumps operating against a closed valve can cause system failure, personal injury and property damage

## NOTICE:

Blackmer truck pumps must only be installed in systems designed by qualified engineering personnel. System design must conform with all applicable regulations and codes and provide warning of all system hazards.

## PUMP IDENTIFICATION

A pump Identification tag, containing the pump serial number, I.D. number, and model designation, is attached to each pump. It is recommended that the data from this tag be recorded and filed for future reference. If replacement parts are needed, or if information pertaining to the pump is required, this data must be furnished to a Blackmer representative.

## TRUCK MOUNTING

The pump will operate satisfactorily in any position. Consult Blackmer factory for vertical shaft mounts. The pump can be bolted to the truck frame or on a saddle hung below the frame, and MUST be adequately supported. Mounting the pump with the cylinder feet down, or with the intake port up, is recommended for thorough draining of the pump.

## PUMP ROTATION

Confirm correct pump rotation by checking the pump rotation arrows respective to pump driver rotation.

## TO CHANGE PUMP ROTATION

Refer to the pump's IOM.

## PUMP SPEED

PTO and hydraulically driven units MUST contain speed control devices to prevent pump speeds above the maximum RPM specifications, regardless of the truck engine unloading speeds. If fluid delivery is less than expected, see the "General Pump Troubleshooting" section

## PTO DRIVE

The pump may be driven by a power take-off through universal joints. When using universal joints, a splined slip joint, properly lubricated, must be used on the connecting jackshaft to prevent end thrust on the pump shaft.

It is very important to install a proper drive line to avoid excessive wear, vibration and noise see Fig. 2 and Table 1.

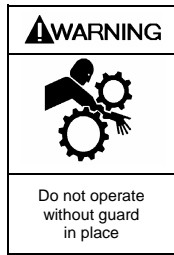

**A drive shaft guard between the PTO and pump must be provided to prevent personal injury, property damage, or death.**

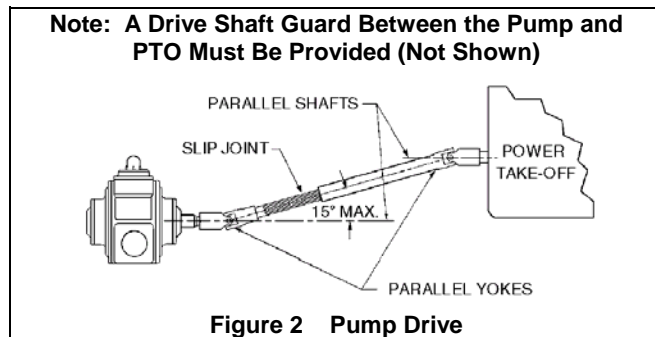

Angle of Drive Shaft		
1° through 5°	6° through 10°	11° through 15°
Very Good	Good	Fair

**Table 1**

### General guidelines to follow for proper pump drive:

1. DO NOT use Square slip joints.
2. Use the least number of jackshafts as is practical.
3. Use an even number of universal joints.
4. The pump shaft and power take-off shaft must be parallel in all respects. Use an angular level measuring device to ensure the PTO and pump shaft are parallel to each other. If necessary, the pump can be shimmed to correct any misalignment. The PTO shaft coming off at the transmission does not need to be perfectly horizontal as long as the pump is shimmed to have its shaft parallel in all respects to the PTO shaft.
5. The yokes of the universals at both ends of the jackshaft must be parallel and in phase.
6. The maximum angle between the jackshaft and the pump shaft is 15 degrees. Refer to Table 1.

Failure to follow any of these guidelines may result in a gallop or uneven turning of the pump rotor, which will in turn cause a surging vibration to the liquid stream and piping system. Contact the supplier of the drive line components for specific design assistance.

## HYDRAULIC DRIVE

The pump may also be driven hydraulically. Hydraulic motors need to be well supported with their shafts parallel to the pump shaft in all respects. Blackmer provides an optional close-coupled hydraulic motor adapter. The adapter provides for straight alignment of a hydraulic motor drive through a solid coupling connected to a straight key shaft. This coupling connection requires grease lubrication every three months at **minimum**. Refer to the "Lubrication" section of the pump manual.

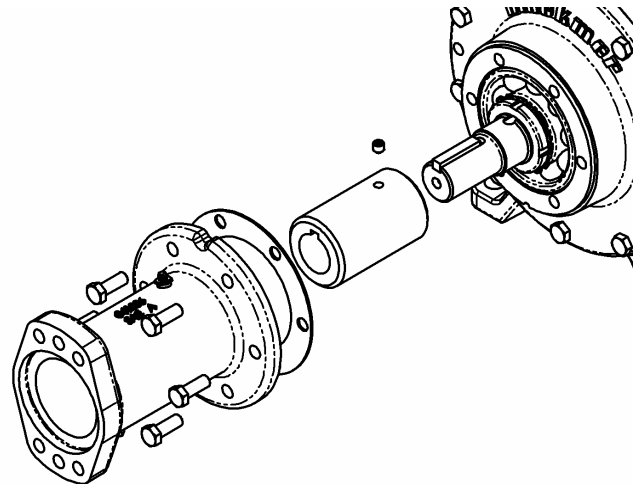

**Figure 3 Hydraulic Drive**

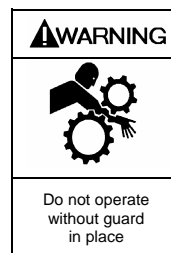

**Operation without shaft protector can cause serious personal injury, major property damage, or death.**



1809 Century Avenue, Grand Rapids, Michigan 49503-1530 U.S.A.  
Telephone: (616) 241-1611 • Fax: (616) 241-3752  
E-mail: [blackmer@blackmer.com](mailto:blackmer@blackmer.com) • [www.blackmer.com](http://www.blackmer.com)